

FEATURES

Low Cost

Low Power: 1.15 mA Max for 5 V Supply

High Speed

400 MHz, -3 dB Bandwidth (G = +1)

4000 V/ μ s Slew Rate

60 ns Overload Recovery

Fast Settling Time of 24 ns

Drive Video Signals on 50 Ω Lines

Very Low Noise

3.5 nV/ $\sqrt{\text{Hz}}$ and 5 pA/ $\sqrt{\text{Hz}}$

5 nV/ $\sqrt{\text{Hz}}$ Total Input Referred Noise @ G = +3 w/500 Ω

Feedback Resistor

Operates on +4.5 V to +12 V Supplies

Low Distortion -70 dB THD @ 5 MHz

Low, Temperature-Stable DC Offset

Available in SOIC-8 and SOT-23-5

APPLICATIONS

Photo-Diode Preamp

Professional and Portable Cameras

Hand Sets

DVD/CD

Handheld Instruments

A-to-D Driver

Any Power-Sensitive High Speed System

PRODUCT DESCRIPTION

The AD8014 is a revolutionary current feedback operational amplifier that attains new levels of combined bandwidth, power, output drive and distortion. Analog Devices, Inc. uses a proprietary circuit architecture to enable the highest performance amplifier at the lowest power. Not only is it technically superior, but is low priced, for use in consumer electronics. This general purpose amplifier is ideal for a wide variety of applications including battery operated equipment.

FUNCTIONAL BLOCK DIAGRAMS

SOIC-8 (R)

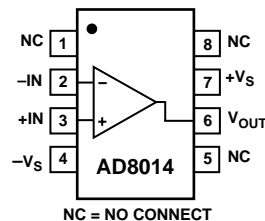

SOT-23-5 (RT)

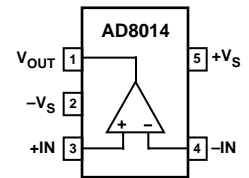

The AD8014 is a very high speed amplifier with 400 MHz, -3 dB bandwidth, 4000 V/ μ s slew rate, and 24 ns settling time. The AD8014 is a very stable and easy to use amplifier with fast overload recovery. The AD8014 has extremely low voltage and current noise, as well as low distortion, making it ideal for use in wide-band signal processing applications.

For a current feedback amplifier, the AD8014 has extremely low offset voltage and input bias specifications as well as low drift. The input bias current into either input is less than 15 μ A at +25°C with a typical drift of less than 50 nA/ $^{\circ}$ C over the industrial temperature range. The offset voltage is 5 mV max with a typical drift less than 10 μ V/ $^{\circ}$ C.

For a low power amplifier, the AD8014 has very good drive capability with the ability to drive 2 V p-p video signals on 75 Ω or 50 Ω series terminated lines and still maintain more than 135 MHz, 3 dB bandwidth.

REV. B

Information furnished by Analog Devices is believed to be accurate and reliable. However, no responsibility is assumed by Analog Devices for its use, nor for any infringements of patents or other rights of third parties which may result from its use. No license is granted by implication or otherwise under any patent or patent rights of Analog Devices.

AD8014—SPECIFICATIONS (@ $T_A = +25^\circ\text{C}$, $V_S = \pm 5\text{ V}$, $R_L = 150\ \Omega$, $R_F = 1\ \text{k}\Omega$, Gain = +2, unless otherwise noted)

Parameter	Conditions	AD8014AR/RT			Units
		Min	Typ	Max	
DYNAMIC PERFORMANCE					
-3 dB Bandwidth Small Signal	$G = +1$, $V_O = 0.2\ \text{V p-p}$, $R_L = 1\ \text{k}\Omega$	400	480		MHz
	$G = -1$, $V_O = 0.2\ \text{V p-p}$, $R_L = 1\ \text{k}\Omega$	120	160		MHz
-3 dB Bandwidth Large Signal	$V_O = 2\ \text{V p-p}$	140	180		MHz
	$V_O = 2\ \text{V p-p}$, $R_F = 500\ \Omega$	170	210		MHz
	$V_O = 2\ \text{V p-p}$, $R_F = 500\ \Omega$, $R_L = 50\ \Omega$		130		MHz
0.1 dB Small Signal Bandwidth	$V_O = 0.2\ \text{V p-p}$, $R_L = 1\ \text{k}\Omega$		12		MHz
0.1 dB Large Signal Bandwidth	$V_O = 2\ \text{V p-p}$, $R_L = 1\ \text{k}\Omega$		20		MHz
Slew Rate, 25% to 75%, $V_O = 4\ \text{V Step}$	$R_L = 1\ \text{k}\Omega$, $R_F = 500\ \Omega$		4600		V/ μs
	$R_L = 1\ \text{k}\Omega$		2800		V/ μs
	$G = -1$, $R_L = 1\ \text{k}\Omega$, $R_F = 500\ \Omega$		4000		V/ μs
	$G = -1$, $R_L = 1\ \text{k}\Omega$		2500		V/ μs
Settling Time to 0.1%	$G = +1$, $V_O = 2\ \text{V Step}$, $R_L = 1\ \text{k}\Omega$		24		ns
Rise and Fall Time 10% to 90%	2 V Step		1.6		ns
	$G = -1$, 2 V Step		2.8		ns
Overload Recovery to Within 100 mV	0 V to $\pm 4\ \text{V Step}$ at Input		60		ns
NOISE/HARMONIC PERFORMANCE					
Total Harmonic Distortion	$f_C = 5\ \text{MHz}$, $V_O = 2\ \text{V p-p}$, $R_L = 1\ \text{k}\Omega$		-68		dB
	$f_C = 5\ \text{MHz}$, $V_O = 2\ \text{V p-p}$		-51		dB
	$f_C = 20\ \text{MHz}$, $V_O = 2\ \text{V p-p}$		-45		dB
SFDR	$f_C = 20\ \text{MHz}$, $V_O = 2\ \text{V p-p}$		-48		dB
Input Voltage Noise	$f = 10\ \text{kHz}$		3.5		nV/ $\sqrt{\text{Hz}}$
Input Current Noise	$f = 10\ \text{kHz}$		5		pA/ $\sqrt{\text{Hz}}$
Differential Gain Error	NTSC, $G = +2$, $R_F = 500\ \Omega$		0.05		%
	NTSC, $G = +2$, $R_F = 500\ \Omega$, $R_L = 50\ \Omega$		0.46		%
Differential Phase Error	NTSC, $G = +2$, $R_F = 500\ \Omega$		0.30		Degree
	NTSC, $G = +2$, $R_F = 500\ \Omega$, $R_L = 50\ \Omega$		0.60		Degree
Third Order Intercept	$f = 10\ \text{MHz}$		22		dBm
DC PERFORMANCE					
Input Offset Voltage			2	5	mV
	$T_{\text{MIN}}-T_{\text{MAX}}$		2	6	mV
Input Offset Voltage Drift			10		$\mu\text{V}/^\circ\text{C}$
Input Bias Current	+Input or -Input		5	15	μA
Input Bias Current Drift			50		nA/ $^\circ\text{C}$
Input Offset Current			5		$\pm\mu\text{A}$
Open Loop Transresistance		800	1300		k Ω
INPUT CHARACTERISTICS					
Input Resistance	+Input		450		k Ω
Input Capacitance	+Input		2.3		pF
Input Common-Mode Voltage Range		± 3.8	± 4.1		V
Common-Mode Rejection Ratio	$V_{\text{CM}} = \pm 2.5\ \text{V}$	-52	-57		dB
OUTPUT CHARACTERISTICS					
Output Voltage Swing	$R_L = 150\ \Omega$	± 3.4	± 3.8		V
	$R_L = 1\ \text{k}\Omega$	± 3.6	± 4.0		V
Output Current	$V_O = \pm 2.0\ \text{V}$	40	50		mA
Short Circuit Current			70		mA
Capacitive Load Drive for 30% Overshoot	2 V p-p, $R_L = 1\ \text{k}\Omega$, $R_F = 500\ \Omega$		40		pF
POWER SUPPLY					
Operating Range		± 2.25	± 5	± 6.0	V
Quiescent Current			1.15	1.3	mA
Power Supply Rejection Ratio	$\pm 4\ \text{V}$ to $\pm 6\ \text{V}$	-55	-58		dB

Specifications subject to change without notice.

SPECIFICATIONS

(@ $T_A = +25^\circ\text{C}$, $V_S = +5\text{ V}$, $R_L = 150\ \Omega$, $R_F = 1\ \text{k}\Omega$, Gain = +2, unless otherwise noted)

Parameter	Conditions	AD8014AR/RT			Units
		Min	Typ	Max	
DYNAMIC PERFORMANCE					
-3 dB Bandwidth Small Signal	$G = +1$, $V_O = 0.2\ \text{V p-p}$, $R_L = 1\ \text{k}\Omega$	345	430		MHz
	$G = -1$, $V_O = 0.2\ \text{V p-p}$, $R_L = 1\ \text{k}\Omega$	100	135		MHz
-3 dB Bandwidth Large Signal	$V_O = 2\ \text{V p-p}$	75	100		MHz
	$V_O = 2\ \text{V p-p}$, $R_F = 500\ \Omega$	90	115		MHz
	$V_O = 2\ \text{V p-p}$, $R_F = 500\ \Omega$, $R_L = 75\ \Omega$		100		MHz
0.1 dB Small Signal Bandwidth	$V_O = 0.2\ \text{V p-p}$, $R_L = 1\ \text{k}\Omega$		10		MHz
0.1 dB Large Signal Bandwidth	$V_O = 2\ \text{V p-p}$		20		MHz
Slew Rate, 25% to 75%, $V_O = 2\ \text{V Step}$	$R_L = 1\ \text{k}\Omega$, $R_F = 500\ \Omega$		3900		V/ μs
	$R_L = 1\ \text{k}\Omega$		1100		V/ μs
	$G = -1$, $R_L = 1\ \text{k}\Omega$, $R_F = 500\ \Omega$		1800		V/ μs
	$G = -1$, $R_L = 1\ \text{k}\Omega$		1100		V/ μs
Settling Time to 0.1%	$G = +1$, $V_O = 2\ \text{V Step}$, $R_F = 1\ \text{k}\Omega$		24		ns
Rise and Fall Time 10% to 90%	2 V Step		1.9		ns
	$G = -1$, 2 V Step		2.8		ns
Overload Recovery to Within 100 mV	0 V to $\pm 2\ \text{V Step}$ at Input		60		ns
NOISE/HARMONIC PERFORMANCE					
Total Harmonic Distortion	$f_C = 5\ \text{MHz}$, $V_O = 2\ \text{V p-p}$, $R_L = 1\ \text{k}\Omega$		-70		dB
	$f_C = 5\ \text{MHz}$, $V_O = 2\ \text{V p-p}$		-51		dB
	$f_C = 20\ \text{MHz}$, $V_O = 2\ \text{V p-p}$		-45		dB
SFDR	$f_C = 20\ \text{MHz}$, $V_O = 2\ \text{V p-p}$		-47		dB
Input Voltage Noise	$f = 10\ \text{kHz}$		3.5		nV/ $\sqrt{\text{Hz}}$
Input Current Noise	$f = 10\ \text{kHz}$		5		pA/ $\sqrt{\text{Hz}}$
Differential Gain Error	NTSC, $G = +2$, $R_F = 500\ \Omega$		0.06		%
	NTSC, $G = +2$, $R_F = 500\ \Omega$, $R_L = 50\ \Omega$		0.05		%
Differential Phase Error	NTSC, $G = +2$, $R_F = 500\ \Omega$		0.03		Degree
	NTSC, $G = +2$, $R_F = 500\ \Omega$, $R_L = 50\ \Omega$		0.30		Degree
Third Order Intercept	$f = 10\ \text{MHz}$		22		dBm
DC PERFORMANCE					
Input Offset Voltage			2	5	mV
	$T_{\text{MIN}} - T_{\text{MAX}}$		2	6	mV
Input Offset Voltage Drift			10		$\mu\text{V}/^\circ\text{C}$
Input Bias Current	+Input or -Input		5	15	μA
Input Bias Current Drift			50		nA/ $^\circ\text{C}$
Input Offset Current			5		$\pm\mu\text{A}$
Open Loop Transresistance		750	1300		k Ω
INPUT CHARACTERISTICS					
Input Resistance	+Input		450		k Ω
Input Capacitance	+Input		2.3		pF
Input Common-Mode Voltage Range		1.2	1.1 to 3.9	3.8	V
Common-Mode Rejection Ratio	$V_{\text{CM}} = 1.5\ \text{V to } 3.5\ \text{V}$	-52	-57		dB
OUTPUT CHARACTERISTICS					
Output Voltage Swing	$R_L = 150\ \Omega$ to 2.5 V	1.4	1.1 to 3.9	3.6	V
	$R_L = 1\ \text{k}\Omega$ to 2.5 V	1.2	0.9 to 4.1	3.8	V
Output Current	$V_O = 1.5\ \text{V to } 3.5\ \text{V}$	30	50		mA
Short Circuit Current			70		mA
Capacitive Load Drive for 30% Overshoot	2 V p-p, $R_L = 1\ \text{k}\Omega$, $R_F = 500\ \Omega$		55		pF
POWER SUPPLY					
Operating Range		4.5	5	12	V
Quiescent Current			1.0	1.15	mA
Power Supply Rejection Ratio	4 V to 5.5 V	-55	-58		dB

Specifications subject to change without notice.

AD8014

ABSOLUTE MAXIMUM RATINGS¹

Supply Voltage	12.6 V
Internal Power Dissipation ²	
Small Outline Package (R)	0.75 W
SOT-23-5 Package (RT)	0.5 W
Input Voltage Common Mode	$\pm V_S$
Differential Input Voltage	± 2.5 V
Output Short Circuit Duration	Observe Power Derating Curves
Storage Temperature Range	-65°C to +150°C
Operating Temperature Range	-40°C to +85°C
Lead Temperature (Soldering 10 sec)	+300°C
ESD (Human Body Model)	+1500 V

NOTES

¹Stresses above those listed under Absolute Maximum Ratings may cause permanent damage to the device. This is a stress rating only, functional operation of the device at these or any other conditions above listed in the operational section of this specification is not implied. Exposure to Absolute Maximum Ratings for any extended periods may affect device reliability.

²Specification is for device in free air at 25°C.

8-Lead SOIC Package $\theta_{JA} = 155^\circ\text{C/W}$.

5-Lead SOT-23 Package $\theta_{JA} = 240^\circ\text{C/W}$.

MAXIMUM POWER DISSIPATION

The maximum power that can be safely dissipated by the AD8014 is limited by the associated rise in junction temperature. The maximum safe junction temperature for plastic encapsulated devices is determined by the glass transition temperature of the

plastic. This is approximately +150°C. Even temporarily exceeding this limit may cause a shift in parametric performance due to a change in the stresses exerted on the die by the package. Exceeding a junction temperature of +175°C may result in device failure.

The output stage of the AD8014 is designed for large load current capability. As a result, shorting the output to ground or to power supply sources may result in a very large power dissipation. To ensure proper operation it is necessary to observe the maximum power derating tables.

Table I. Maximum Power Dissipation vs. Temperature

Ambient Temp °C	Power Watts SOT-23-5	Power Watts SOIC
-40	0.79	1.19
-20	0.71	1.06
0	0.63	0.94
+20	0.54	0.81
+40	0.46	0.69
+60	0.38	0.56
+80	0.29	0.44
+100	0.21	0.31

ORDERING GUIDE

Model	Temperature Range	Package Descriptions	Package Options	Brand Code
AD8014AR ¹	-40°C to +85°C	8-Lead SOIC	SO-8	Standard
AD8014ART ²	-40°C to +85°C	5-Lead SOT-23	RT-5	HAA
AD8014AChips ³	-40°C to +85°C	Not Applicable	Waffle Pak	Not Applicable

NOTES

¹The AD8014AR is also available in 13" Reels of 2500 each and 7" Reels of 750 each.

²Except for samples, the AD8014ART is only available in 7" Reels of 3000 each and 13" Reels of 10000 each.

³The AD8014A Chips are available only in Waffle Pak of 400 each. The thickness of the AD8014A Chip is 12 mils \pm 1 mil. The Substrate should be tied to the +V_S source.

CAUTION

ESD (electrostatic discharge) sensitive device. Electrostatic charges as high as 4000 V readily accumulate on the human body and test equipment and can discharge without detection. Although the AD8014 features proprietary ESD protection circuitry, permanent damage may occur on devices subjected to high energy electrostatic discharges. Therefore, proper ESD precautions are recommended to avoid performance degradation or loss of functionality.



Typical Performance Characteristics—AD8014

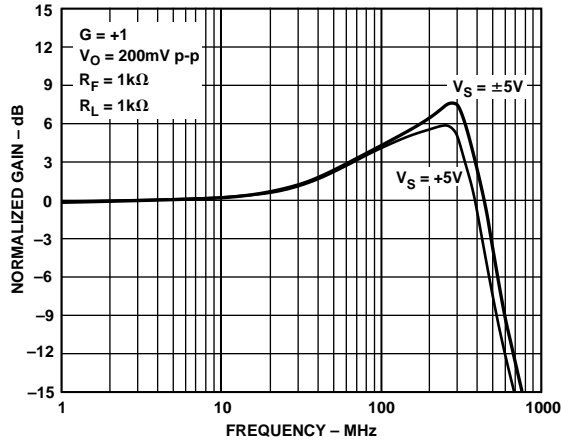

Figure 1. Frequency Response, $G = +1$, $V_S = \pm 5\text{ V}$ and $+5\text{ V}$

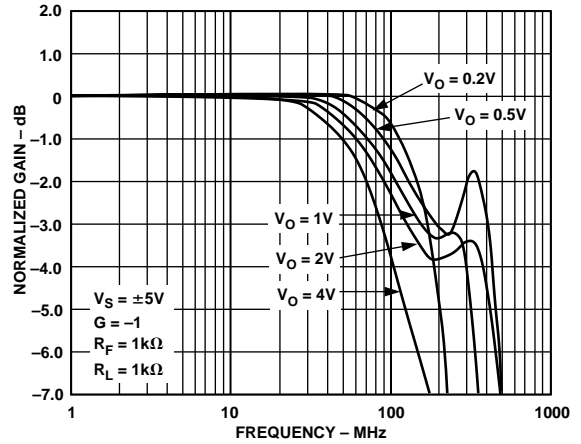

Figure 4. Bandwidth vs. Output Level—Gain of -1 , Dual Supply

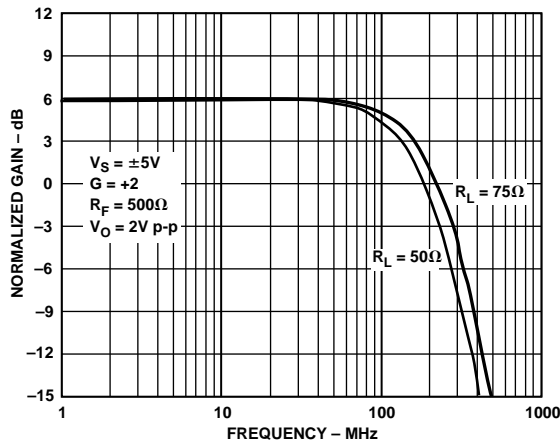

Figure 2. Frequency Response, $G = +2$, $V_O = 2\text{ V p-p}$

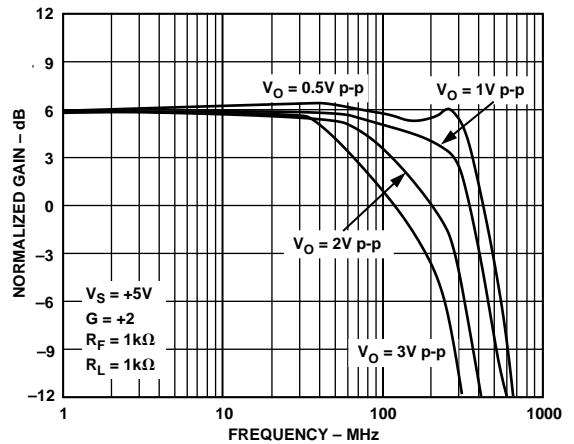

Figure 5. Bandwidth vs. Output Level—Single Supply, $G = +2$

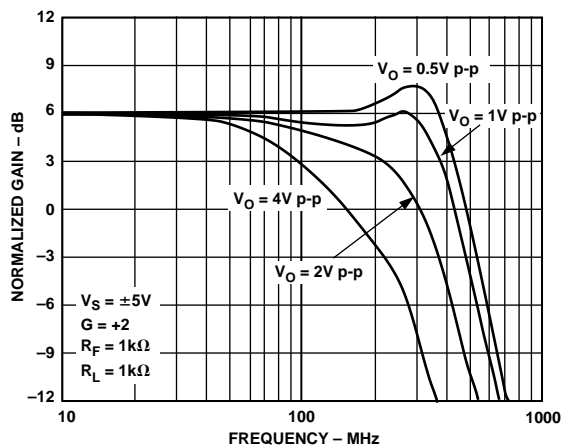

Figure 3. Bandwidth vs. Output Voltage Level—Dual Supply, $G = +2$

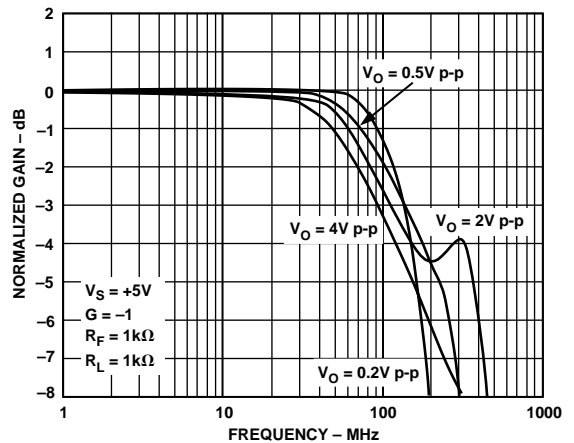

Figure 6. Bandwidth vs. Output Level—Single Supply, Gain of -1

AD8014

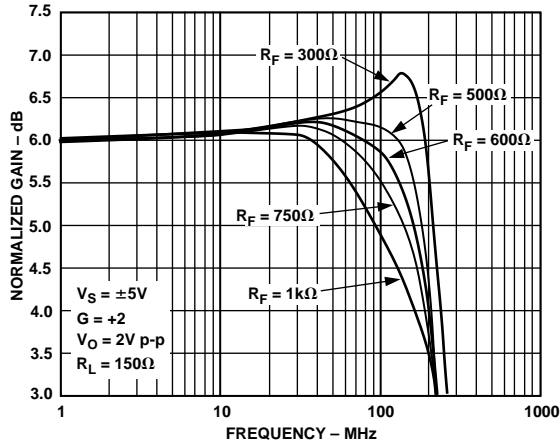

Figure 7. Bandwidth vs. Feedback Resistor—Dual Supply

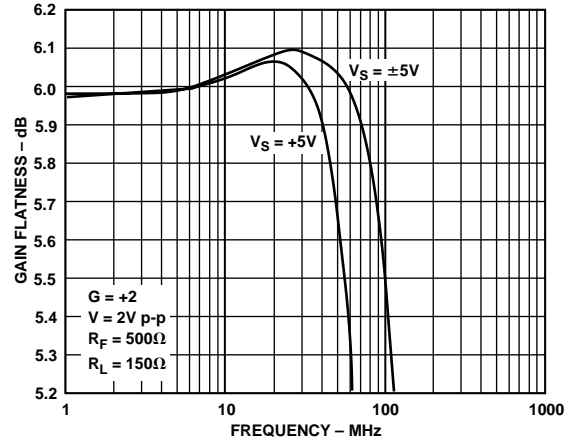

Figure 10. Gain Flatness—Large Signal

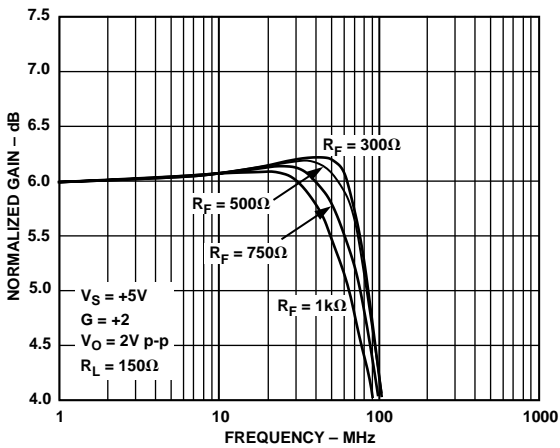

Figure 8. Bandwidth vs. Feedback Resistor—Single Supply

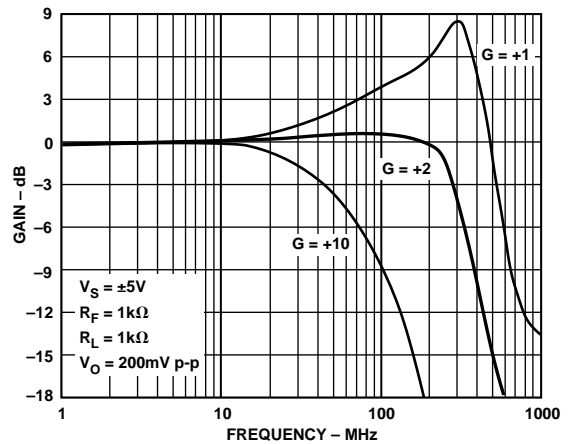

Figure 11. Bandwidth vs. Gain—Dual Supply, $R_F = 1k\Omega$

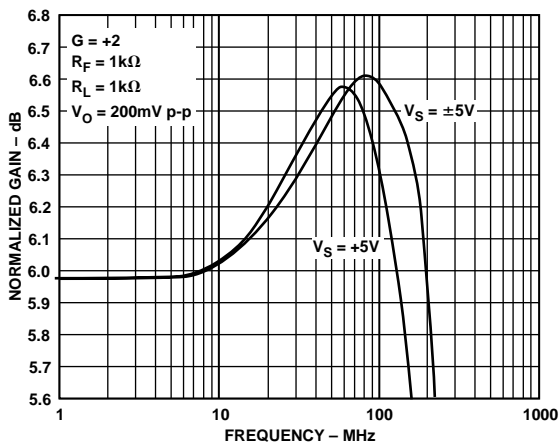

Figure 9. Gain Flatness—Small Signal

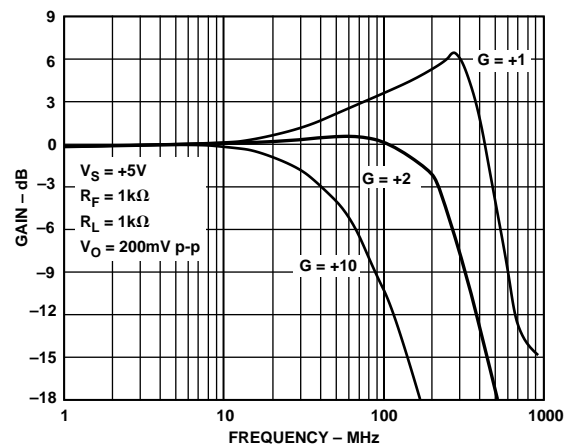

Figure 12. Bandwidth vs. Gain—Single Supply

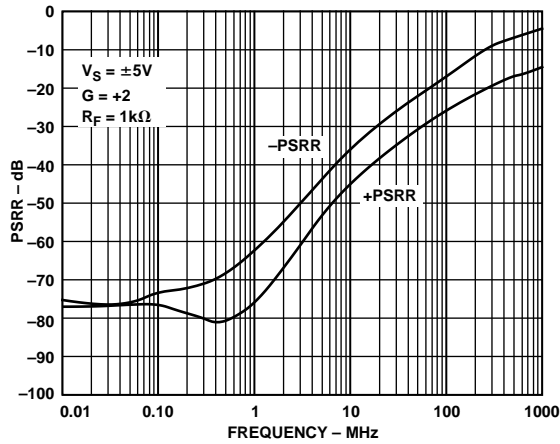

Figure 13. PSRR vs. Frequency

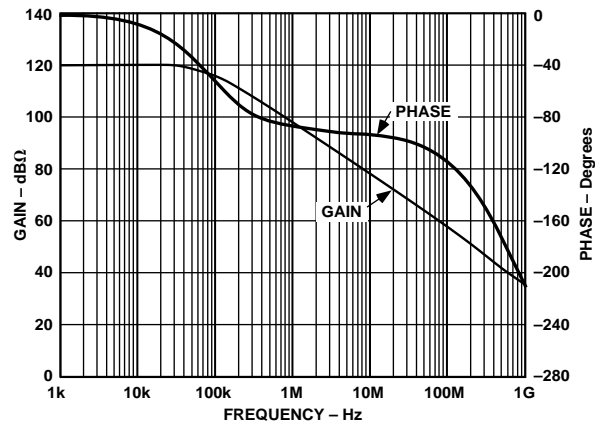

Figure 16. Transimpedance Gain and Phase vs. Frequency

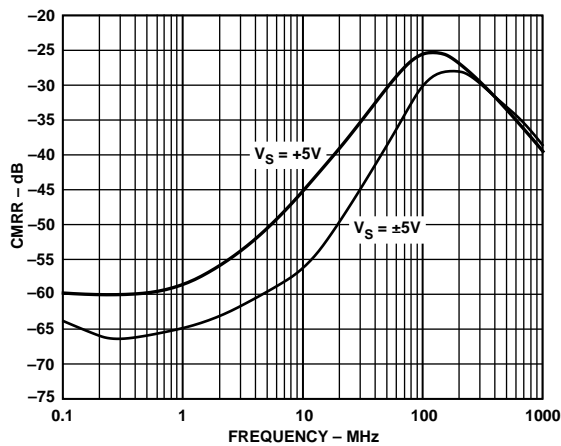

Figure 14. CMRR vs. Frequency

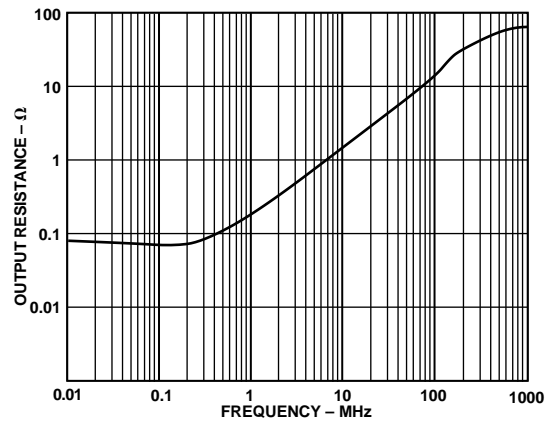

Figure 17. Output Resistance vs. Frequency, $V_S = \pm 5 V$ and $+5 V$

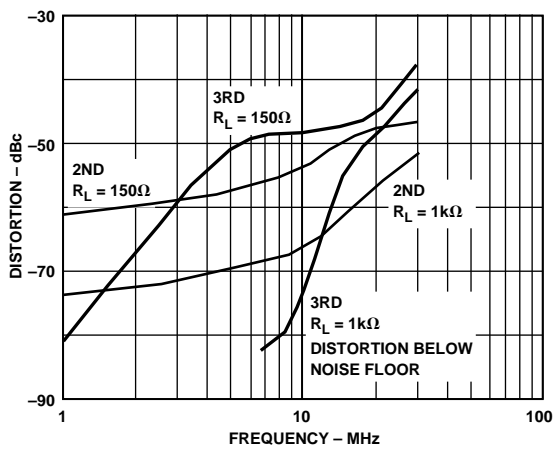

Figure 15. Distortion vs. Frequency; $V_S = \pm 5 V$, $G = +2$

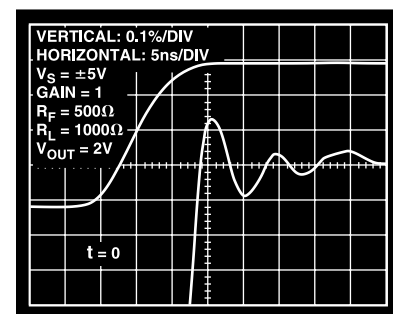

Figure 18. Settling Time

AD8014

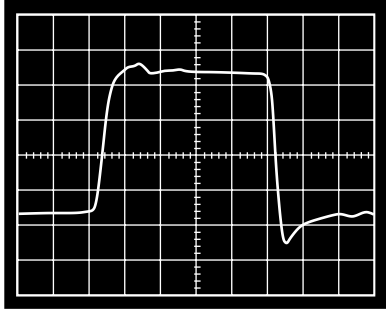

Figure 19. Large Signal Step Response; $V_S = \pm 5 V$, $V_O = 4 V$ Step

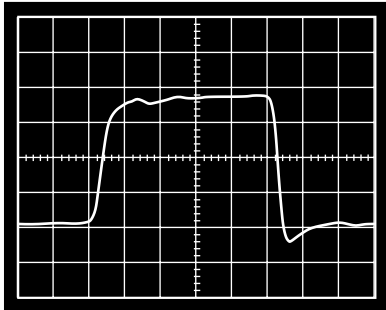

Figure 20. Large Signal Step Response; $V_S = +5 V$, $V_O = 2 V$ Step

Note: On Figures 19 and 20 $R_F = 500 \Omega$, $R_S = 50 \Omega$ and $C_L = 20 \text{ pF}$.

APPLICATIONS

CD ROM and DVD Photodiode Preamp

High speed Multi-X CD ROM and DVD drives require high frequency photodiode preamps for their read channels. To minimize the effects of the photodiode capacitance, the low impedance of the inverting input of a current feedback amplifier is advantageous. Good group delay characteristics will preserve the pulse response of these pulses. The AD8014, having many advantages, can make an excellent low cost, low noise, low power, and high bandwidth photodiode preamp for these applications.

Figure 21 shows the circuit that was used to imitate a photodiode preamp. A photodiode for this application is basically a high impedance current source that is shunted by a small capacitance. In this case, a high voltage pulse from a Picosecond Pulse Labs Generator that is ac-coupled through a $20 \text{ k}\Omega$ resistor is used to simulate the high impedance current source of a photodiode. This circuit will convert the input voltage pulse into a small charge package that is converted back to a voltage by the AD8014 and the feedback resistor.

In this case the feedback resistor chosen was $1.74 \text{ k}\Omega$, which is a compromise between maintaining bandwidth and providing sufficient gain in the preamp stage. The circuit preserves the pulse shape very well with very fast rise time and a minimum of overshoot as shown in Figure 22.

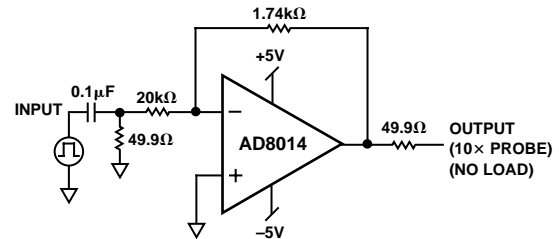

Figure 21. AD8014 as a Photodiode Preamp

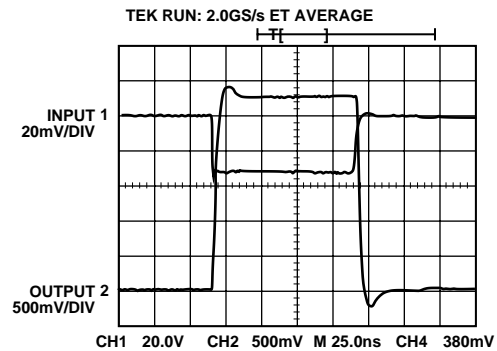

Figure 22. Pulse Response

Video Drivers

The AD8014 easily drives series terminated cables with video signals. Because the AD8014 has such good output drive you can parallel two or three cables driven from the same AD8014. Figure 23 shows the differential gain and phase driving one video cable. Figure 24 shows the differential gain and phase driving two video cables. Figure 25 shows the differential gain and phase driving three video cables.

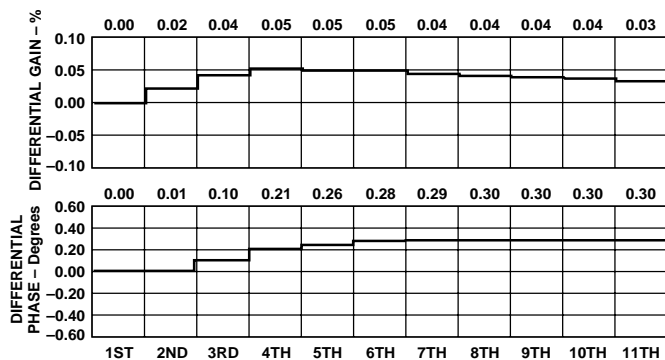

Figure 23. Differential Gain and Phase $R_F = 500, \pm 5 V, R_L = 150 \Omega$, Driving One Cable, $G = +2$

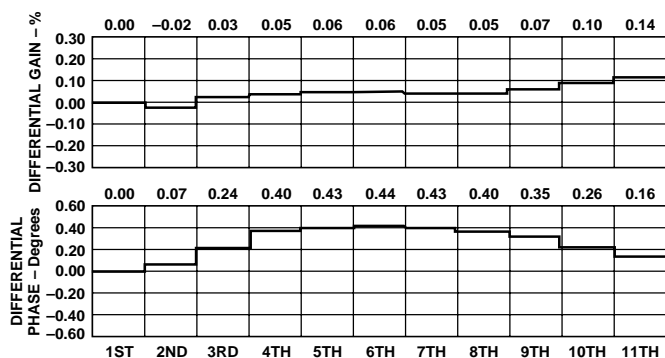

Figure 24. Differential Gain and Phase $R_F = 500, \pm 5 V, R_L = 75 \Omega$, Driving Two Cables, $G = +2$

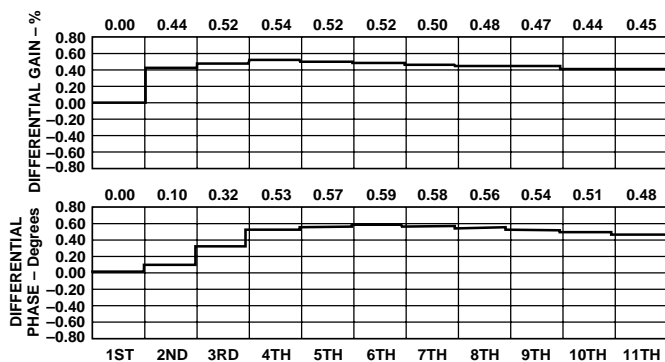

Figure 25. Differential Gain and Phase $R_F = 500, \pm 5 V, R_L = 50 \Omega$, Driving Three Cables, $G = +2$

DRIVING CAPACITIVE LOADS

The AD8014 was designed primarily to drive nonreactive loads. If driving loads with a capacitive component is desired, best settling response is obtained by the addition of a small series resistance as shown in Figure 26. The accompanying graph shows the optimum value for R_{SERIES} vs. Capacitive Load. It is worth noting that the frequency response of the circuit when driving large capacitive loads will be dominated by the passive roll-off of R_{SERIES} and C_L .

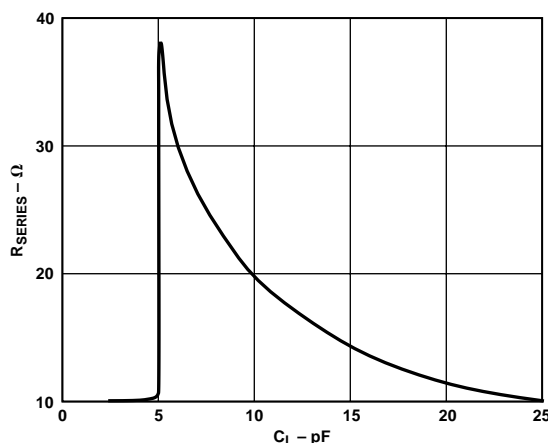

Figure 26. Driving Capacitive Load

Choosing Feedback Resistors

Changing the feedback resistor can change the performance of the AD8014 like any current feedback op amp. The table below illustrates common values of the feedback resistor and the performance which results.

Table II.

Gain	R_F	R_G	-3 dB BW $V_O = \pm 0.2 V$ $R_L = 1 k\Omega$	-3 dB BW $V_O = \pm 0.2 V$ $R_L = 150 \Omega$
+1	1 k Ω	Open	480	430
+2	1 k Ω	1 k Ω	280	260
+10	1 k Ω	111 Ω	50	45
-1	1 k Ω	1 k Ω	160	150
-2	1 k Ω	499 Ω	140	130
-10	1 k Ω	100 Ω	45	40
+2	2 k Ω	2 k Ω	200*	180*
+2	750 Ω	750 Ω	260*	210*
+2	499 Ω	499 Ω	280*	230*

* $V_O = \pm 1 V$.

OUTLINE DIMENSIONS

Dimensions shown in inches and (mm).

**8-Lead Plastic SOIC
(SO-8)**

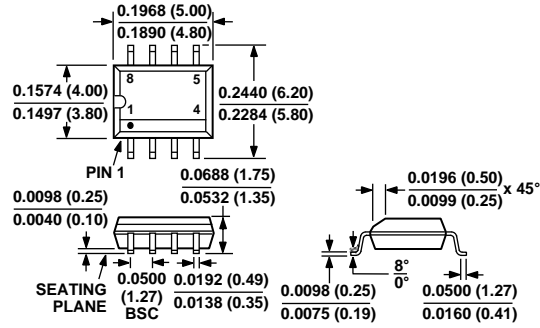

**5-Lead Plastic Surface Mount (SOT-23)
(RT-5)**

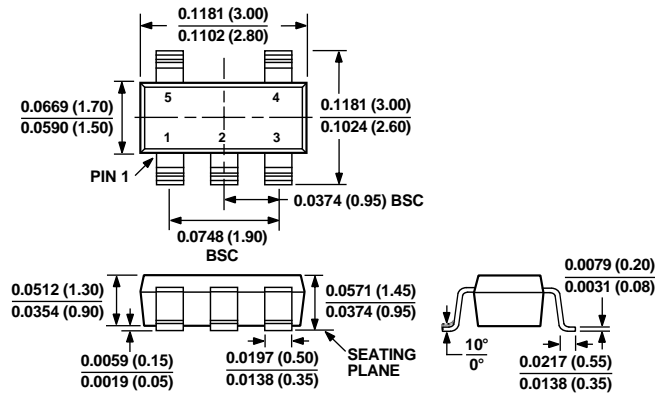

C3439b-0-12/99

PRINTED IN U.S.A.